

Wap

CATÁLOGO DE PEÇAS PARA REPOSIÇÃO



MARTELETE COMBINADO EMPR900K SDS PLUS

FW008313 (127V)
FW008314 (220V)

REVISÃO: 02 - JUNHO/2022
REFERÊNCIA: VEG02.114

O conteúdo deste documento não deve ser reproduzido ou cedido a terceiros sem a autorização prévia da Fresnomaq Indústria de Máquinas S/A

Lista de revisões

N°	DESCRIÇÃO	DATA
0	EMISSÃO INICIAL	23/03/2021
1	ITEM FW008353 UNIFICADO COM O KIT FW008351	17/05/2022
	INCLUSÃO DOS CÓDIGOS Fw008315, Fw008316, ECB00071, ECB00072	
2	INCLUSÃO DO ITEM Fw008970	14/06/2022



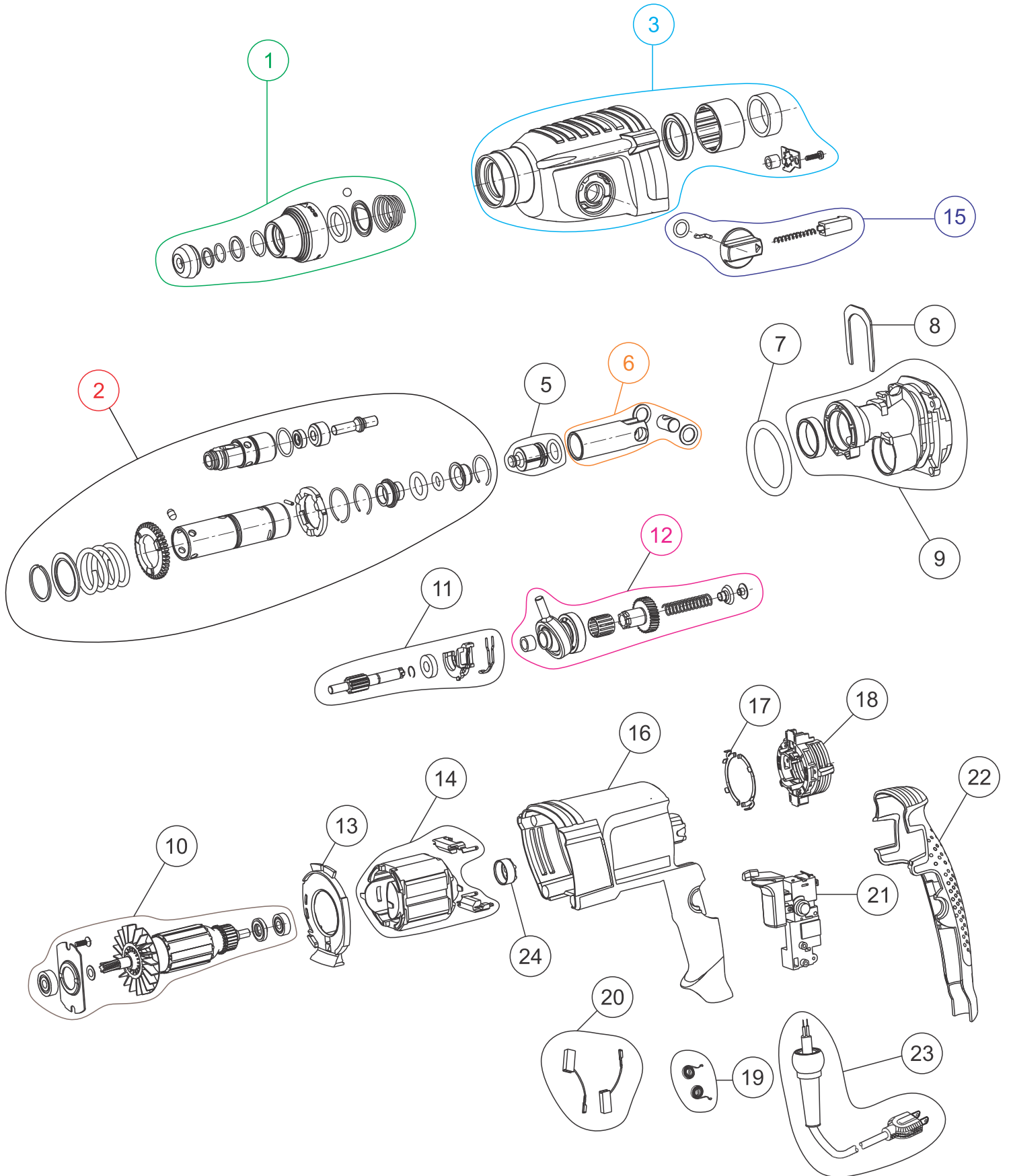





Vista explodida





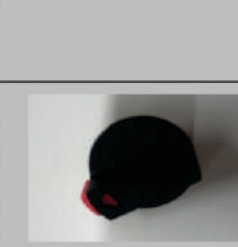

Lista de peças

POS	CÓDIGO	DESCRIÇÃO	QUANT.	FOTO
1	FW008350	TAMPA PROTETORA COM KIT RETENÇÃO + ARRUELA DE ARRASTE	1	
2	FW008351	KIT TUBO COMPLETO + ADMIÇÃO DA FERRAMENTA	1	
3	FW008352	CAIXA DO CILINDRO	1	
5	FW008354	BATEDOR	1	
6	FW008355	CILINDRO DO PISTÃO	1	
7	FW008356	ANEL DE VEDAÇÃO 53x7mm	1	
8	FW008357	CHAPA DE FIXAÇÃO	1	
9	FW008358	FLANGE INTERMEDIARIO	1	
10	FW008359	INDUZIDO 127V	1	
	FW008360	INDUZIDO 220V		

Lista de peças

11	FW008361	EIXO CASTELO	1	
12	FW008362	MANCAL DE ACIONAMENTO COMPLETO	1	
13	FW008363	DEFLETOR	1	
14	FW008364	BOBINA 127V	1	
	FW008365	BOBINA 220V		
15	FW008366	CHAVE SELETORA DE FUNÇÃO	1	
16	FW008367	CAIXA DO MOTOR	1	
17	FW008368	SUPORTE BI PARTIDO	2	
18	FW008369	SUPORTE DE ESCOVA	1	
19	FW008370	KIT TRAVA ESCOVA	1	

Lista de peças

20	FW008371	KIT ESCOVA DE CARVÃO	1	
21	FW008372	INTERRUPTOR 127V	1	
	FW008970	INTERRUPTOR 220V		
22	FW008373	TAMPA DA CAIXA	1	
23	FW008374	CABO ELETRICO 2x1mm	1	
24	FW008376	BUCHAO DO ROLAMENTO	1	

Vista explodida

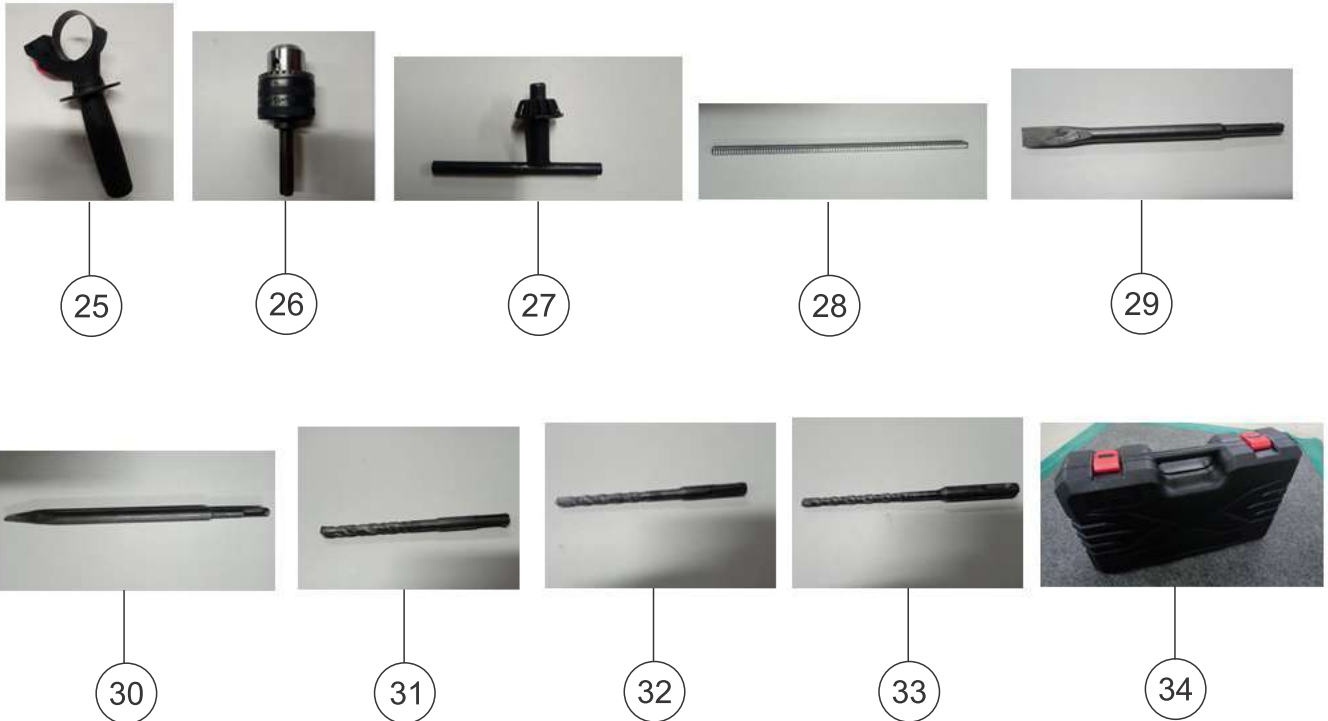

POS	CÓDIGO	DESCRIÇÃO	QUANT.
25	FW008377	PUNHO AUXILIAR COMPLETO	1
26	FW008378	KIT MANDRIL 1/2"	1
27	FW008379	CHAVE DO MANDRIL	1
28	FW008380	REGUA	1
29	FW008381	TALHADEIRA	1
30	FW008382	PONTEIRA	1
31	FW008383	BROCA 10mm	1
32	FW008384	BROCA 8mm	1
33	FW008385	BROCA 6mm	1
34	FW008386	MALETA	1
*	FW008315	CX WAP MARTELETE COMBINADO EMPR900K SDS PLUS	1
*	FW008316	MANUAL DE INSTR WAP MARTELETE COMBINADO EMPR900K SDS PLUS	1
*	ECB00071	ETIQ C. BAR WAP MARTELETE COMBINADO EMPR900K SDS PLUS 127V	1
*	ECB00072	ETIQ C. BAR WAP MARTELETE COMBINADO EMPR900K SDS PLUS 220V	1

Esquema eléctrico

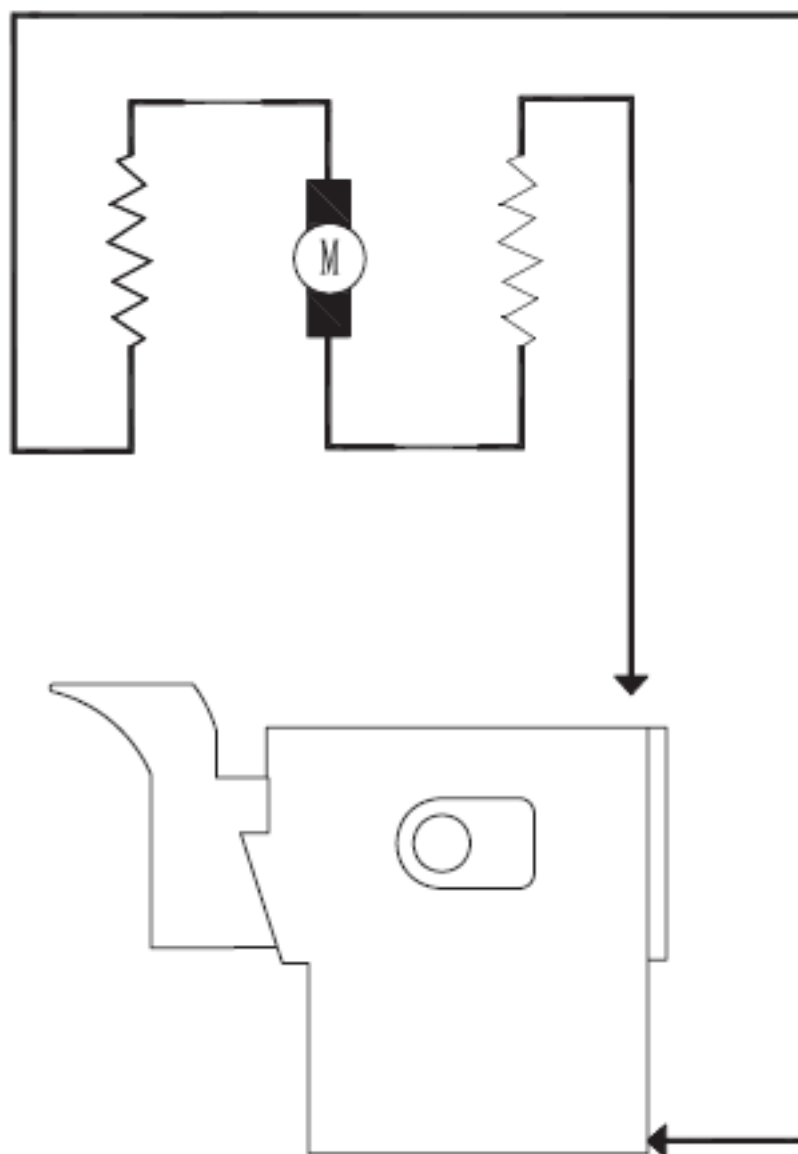



Fresnomaq Indústria de Máquinas S/A
Tel.: (41) 3513-9600 - Fax: (41) 3513-9630
Rua Antônio Singer, 200 - São José dos Pinhais, PR, Brasil
www.wap.ind.br - wap@wap.ind.br