

Wap[®]

VISTA EXPLODIDA







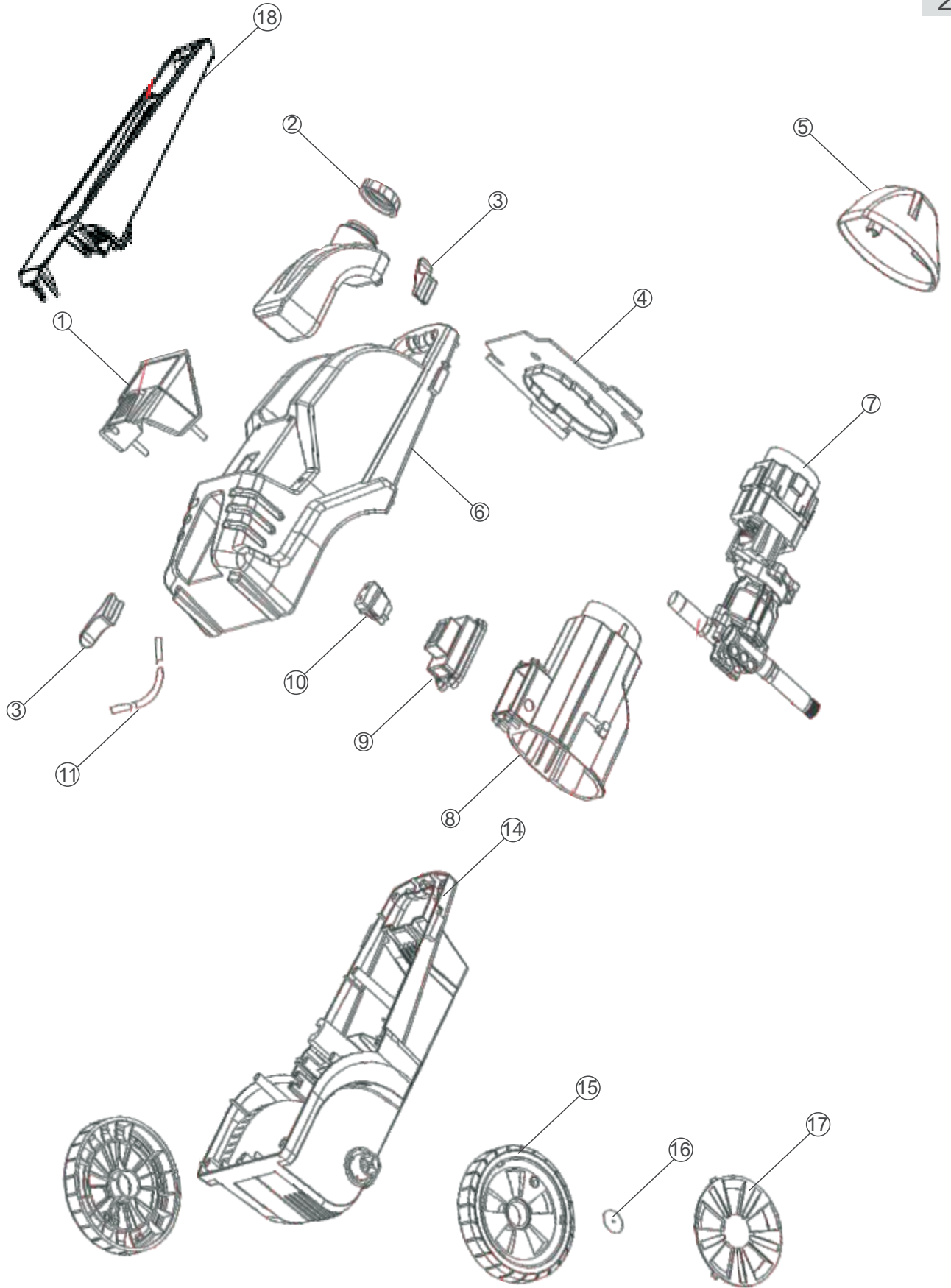











FORTE MIX

Vista Explodida









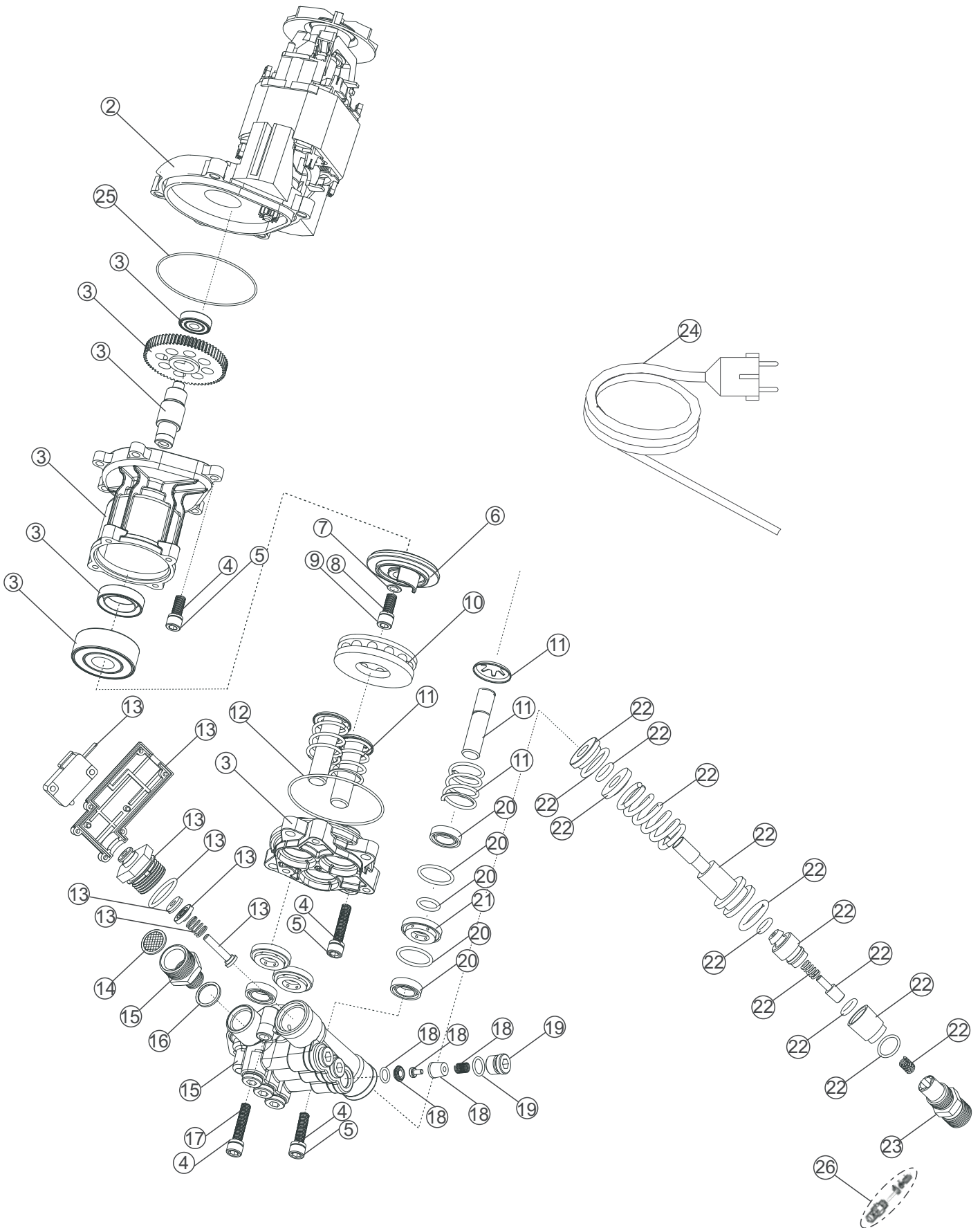

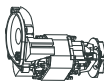
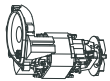
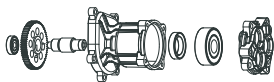

Lista De Peças

Pos.	Código	Descrição	Qtde.	Desenho
1	FW004059	ESCUDO WAP FORTE MIX	1	
2	FW004354	RECIPIENTE DE DETERGENTE COM TAMPA	1	
3	FW001171	SUPORTE CABO ELÉTRICO	2	
4	FW001172	SEPARADOR DE AMBIENTES	1	
5	FW001173	PROTEÇÃO SUPERIOR DO MOTOR	1	
6	FW001186	CARENAGEM FRONTAL	1	
7	FW001174	CONJ. MOTOBOMBA 127V (SOMENTE VENDA)	1	
7	FW001175	CONJ. MOTOBOMBA 220V (SOMENTE VENDA)	1	
8	FW001176	PROTEÇÃO DO MOTOR	1	
9	FW001177	CAIXA DE LIGAÇÃO	1	
10	FW001178	INTERRUPTOR	1	
11	70013001	MANG. CRISTAL 1/4x2,0 (400mm)	1	
14	FW001179	CARENAGEM TRASEIRA	1	
15	FW001180	RODA	2	
16	FW000215	ARRUELA 35x10mm TRAVA RODA	2	
17	FW001182	CALOTA	2	
18	FW003024	ALÇA LONGA	1	





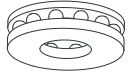



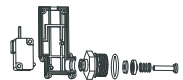

Vista Explodida

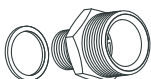
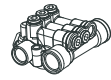

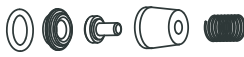
Lista De Peças

Item	Código	Descrição	Qtde.	Desenho
2	VA90-0078	MOTOR 127V 50-60Hz /1600W	1	
2	VA90-078A	MOTOR 220V 50-60Hz /1600W	1	
3	FW001147	CONJUNTO ENGRENAGEM E GUIA PISTÕES	1	
4	70001006	ARRUELA DE PRESSÃO 6mm	7	
5	VG70-0018	PARAFUSO ALLEN M6x25	12	
6	APW90-74	CAME 127V 9°	1	
6	APW90-74A	CAME 220V 12°	1	
7	50186000	ARRUELA LISA 8mm	1	
8	70001008	ARRUELA DE PRESSÃO 8mm	1	
9	VB70-0029	PARAFUSO ALLEN M8x20	1	
10	VG70-0054	ROLAMENTO DE ESFERAS LINHA DOMÉSTICA	1	
11	VB70-49-51	KIT PISTÕES 12mm	1	
12	50043202	O-RING 58,42x2,62 (2141)	1	

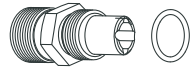
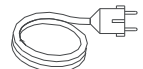
Lista De Peças

Item	Código	Descrição	Qtde.	Desenho
13	VG70-24-31	CONJUNTO MICRO CPL	1	
14	VB70-0018	FILTRO ENTRADA DE ÁGUA	1	
15	FW001183	KIT ENTRADA DE ÁGUA	1	
16	VG70-0017	CABEÇOTE	1	
17	30020115	PARAFUSO M6x35	1	
18	VG70-36-40	KIT VALVULA DE SUCÇÃO/PRESSÃO	1	
19	VG70-41-42	KIT TAMPÃO DE VALVULAS	1	
20	VB70-44-48	KIT VEDAÇÃO	1	
21	VB70-0040	ANEL CENTRALIZADOR	1	
22	VG70-03-16	KIT VALVULA BPS	1	
23	FW001184	CONEXÃO SAÍDA ÁGUA	1	
24	VB70-0060	CABO 2x1mm ² 5 METROS	1	
25	FW001150	O'RING 82,27x1,78 (2042)	1	
26	FW001185	KIT INJETOR DE SHAMPOO WAP FORTE	1	

Acessórios

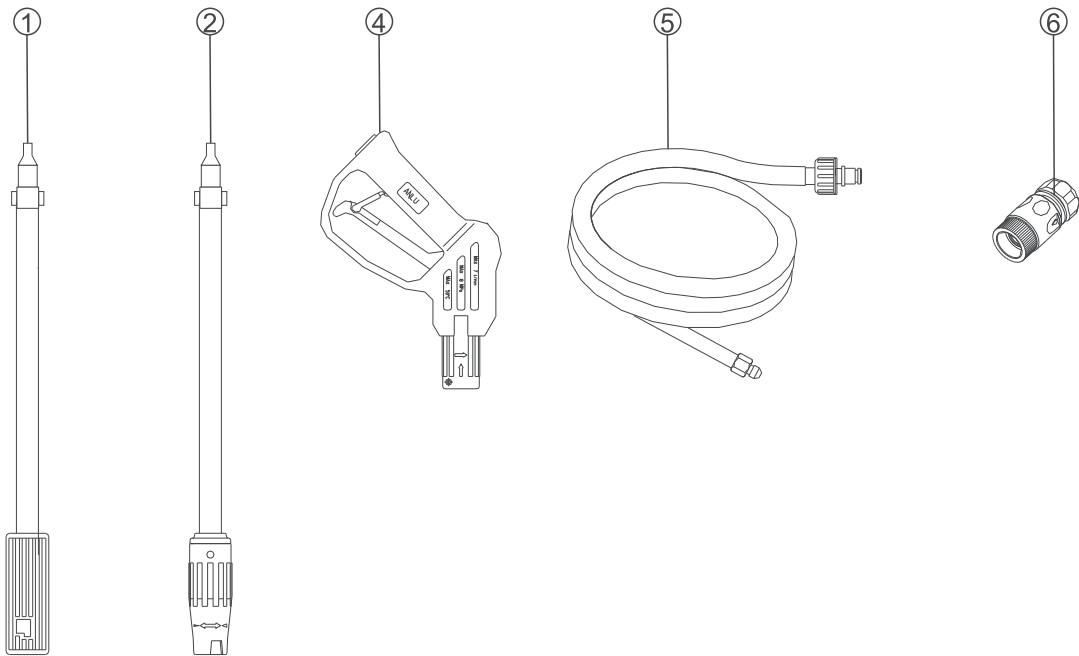

Item	Código	Descrição	Qtde.	Desenho
1	20011208	BAIONETA ALUMINIO ENCAIXE FINO	1	
2	FW001142	LANÇA VARIO C/ BICO REGULAVEL 70BAR	1	
4	FW002970	PISTOLA M14 ENCAIXE FINO	1	
5	FW003108	MANG. AP 5M CONEX M22 PINO 15 CONEX M14	1	
6	VB70-0059	ENGATE RÁPIDO	1	



Fresnomaq Indústria de Máquinas S/A
Tel.: (41) 2102 0300 - Fax: 2102 0334
Rua Francisco Dal Negro, 3400, São José dos Pinhais, Pr, Brasil
www.wap.ind.br - wap@wap.ind.br