

Wap[®]



ENDURO TRIPLEX

catálogo para reposição de peças

Setembro/2011
Rev. A



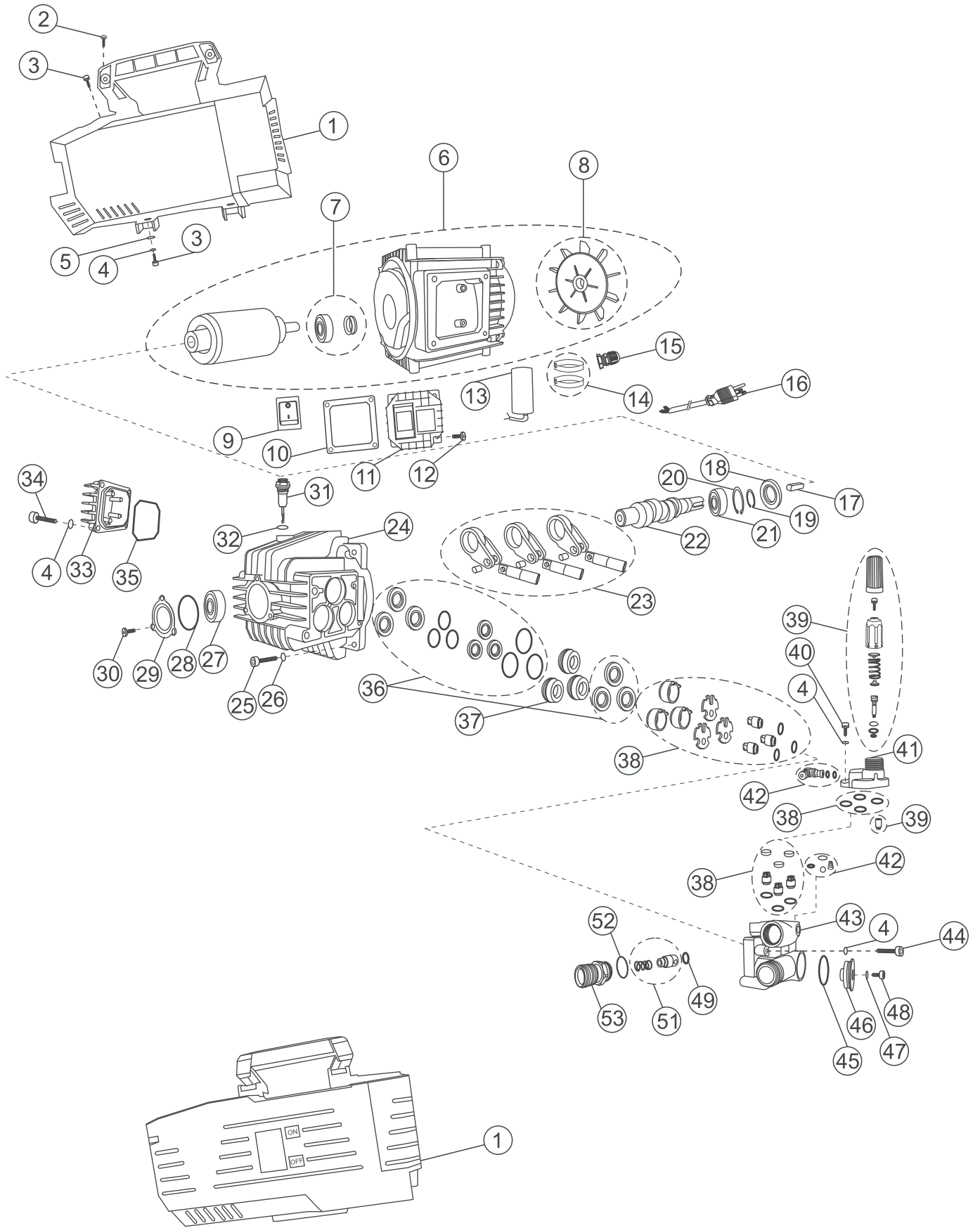























Vista Explodida



Lista De Peças 1

Pos: Do Item	Código	Descrição	Qtde.	Desenho
1	20011026	CONJUNTO CARENAGEM DIR/ESQU ENDURO TX	1	
2	43021000	PARF AA 4,8x13 CP-FC NZ	2	
3	50173000	PARF ALLEN CC M6x16 ZN	8	
4	70001006	ARR PRESS 6mm ZN	4	
5	41511000	ARR. LISA A6x1,5	4	
6	20011028	MOTOR 127V/ 60Hz WAP ENDURO TX	1	
6	20011029	MOTOR 220V/ 60Hz WAP ENDURO TX	1	
7	19524000	ROLAMENTO 6203 2RS	1	
8	20011027	VENTOINHA MOTOR WAP ENDURO TX	1	
9	60867000	INTERRUPTOR	1	
10	20011040	BORRACHA DE VEDAÇÃO CX ELÉTRICA ENDURO TX	1	
11	20011041	CAIXA ELÉTRICA ENDURO TX	1	
12	70007063	PARF. M4x16 CP-FC ZN	4	
13	20011042	CAPACITOR 127V 110uF 250VAC ENDURO	1	
13	20011043	CAPACITOR 220V 40uF 450VAC ENDURO TX	1	
14	20011044	ABRAÇADEIRA CAPACITOR ENDURO TX	2	
15	70006002	PRENSA CABO PG 13,5 ROSCA CURTA	1	
16	70000313	CABO ELÉTRICO 3x2,5mm	1	
17	20011045	CHAVETA VIRABREQ BOMBA ENDURO TX	1	
18	20011046	RETENTOR 17x47x7 VIRABREQUIM ENDURO TX	1	
19	20011047	ANEL ELÁSTICO P/ EIXO 17mm ENDURO TX	1	
20	20011048	ANEL ELÁSTICO P/ FURO 47mm ENDURO TX	1	
21	30010030	ROLAMENTO 6303 / P6	1	
22	20011049	VIRABREQUINHO BOMBA ENDURO	1	
23	20011050	KIT PISTÕES E BIELAS ENDURO TX	1	
24	20011051	CARÇA DA BOMBA ENDURO TX	1	
25	44072603	PARF ALLEN M5x30	4	
26	70001006	ARR. PRESS. A5x1,5 ZN	4	







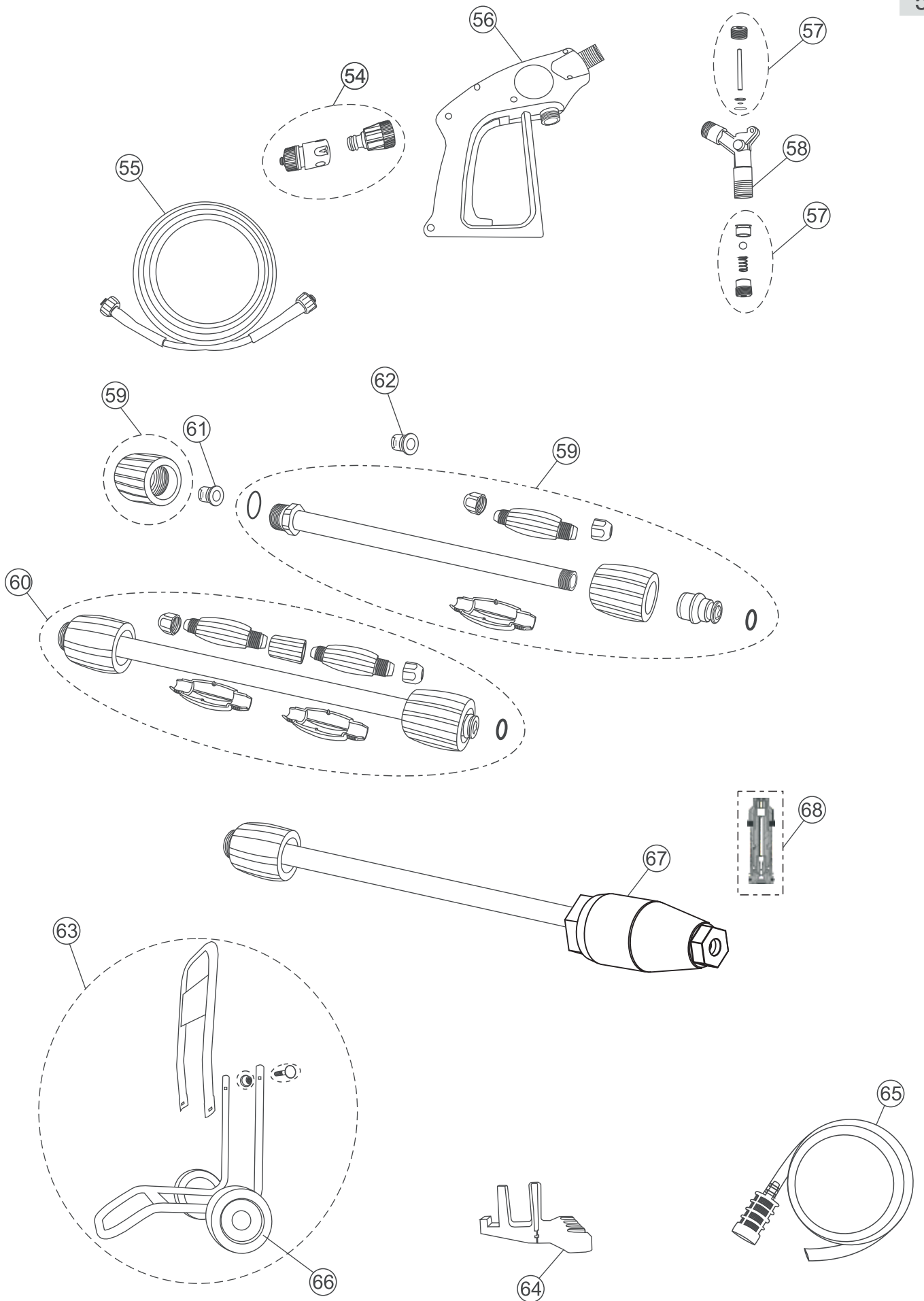



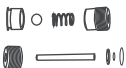

Lista De Peças

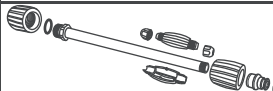
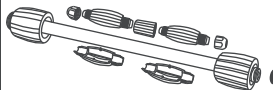
Pos: Do Item	Código	Descrição	Qtde.	Desenho
27	20011053	ROLAMENTO 6202 / P6	1	
28	70000246	ANEL O'RING 34,65x1,78 2028	1	
29	20011054	TAMPA ROLAMENTO	1	
30	43038012	PARF. CP-FC 3,8x7,8	3	
31	20011056	TAMPA MEDIDORA DE ÓLEO	1	
32	15001000	ANEL O'RING 15,6x1,78 2016	1	
33	20011057	TAMPA BOMBA	1	
34	VG70-0018	PARF. ALLEN 5,8x25	4	
35	70020342	ANEL O'RING 63,22x1,78 2037	1	
36	20011020	KIT VEDAÇÃO DA BOMBA	1	
37	20011058	ANEL CENTRALIZADOR	3	
38	20011033	KIT VALV SUCÇÃO/PRESSÃO	1	
39	20011059	VALVULA BAYPASS	1	
40	57071000	PARF ALLEN CC M6x20 AÇO 12,9 PRETO	4	
41	20011036	BLOCO BAYPASS	1	
42	20011034	KIT VALV. S/P SHAMPOO	1	
43	20011055	CABEÇOTE	1	
44	20011023	PARF ALLEN CC M6x45 ZN	4	
45	15063900	ANEL O'RING 29,87x1,78 2025	1	
46	20011038	TAMPA CABEÇOTE	1	
47	70000237	ANEL O'RING 4,42x2,62	1	
48	50173000	PARF ALLEN CC M6x16 ZN	1	
49	70000237	ANEL O'RING 4,47x2,5	1	
51	20011060	KIT VALVULA MOLA RETENÇÃO	1	
52	70000296	ANEL O'RING 17,17x1,78 2017	1	
53	20011061	CONEXÃO SAÍDA M21xM21	1	

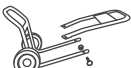
Vista Explodida



Lista De Peças 2

Item	Código	Descrição	Qtde.	Desenho
54	VB70-0059	ENGATE RÁPIDO	1	
55	61115002	MANGUEIRA AP 1/4 CPL 10M	1	
56	61035000	PISTOLA CPL WAP TST	1	
57	61041000	KIT REPARO PISTOLA	1	
58	70060011	CORPO PISTOLA	1	
59	70018090	LANÇA 330mm AÇO INOX CPL	1	
60	70018091	PROLONGADOR PARA LANÇA INOX	1	
61	78130014	BICO AP 1506 TROCA RAPIDO	1	
62	78130013	BICO P/ SHAMPOO TROCA RAPIDO	1	
63	31070034	CHASSI ENDURO TX / AX CPL	1	
64	64103920	SUPORTE ACES PROF 1800/WAP ENDURO	1	
65	20011062	MANGUEIRA CRISTAL	1	
66	Fw000706	RODA 150x40mm	2	
67	70018098	BICO TURBO COM LANÇA INOX 330mm 1,60mm CPL	1	
68	52004161	KIT CORPO ROT BICO TURBO 1,60	1	



Marca de Profissional

Fresnomaq Indústria de Máquinas S/A
Tel.: (41) 2102 0300 - Fax: 2102 0334
Rua Francisco Dal Negro, 3400, São José dos Pinhais, Pr, Brasil
www.wap.ind.br - wap@wap.ind.br