

Wap[®]

VISTA EXPLODIDA







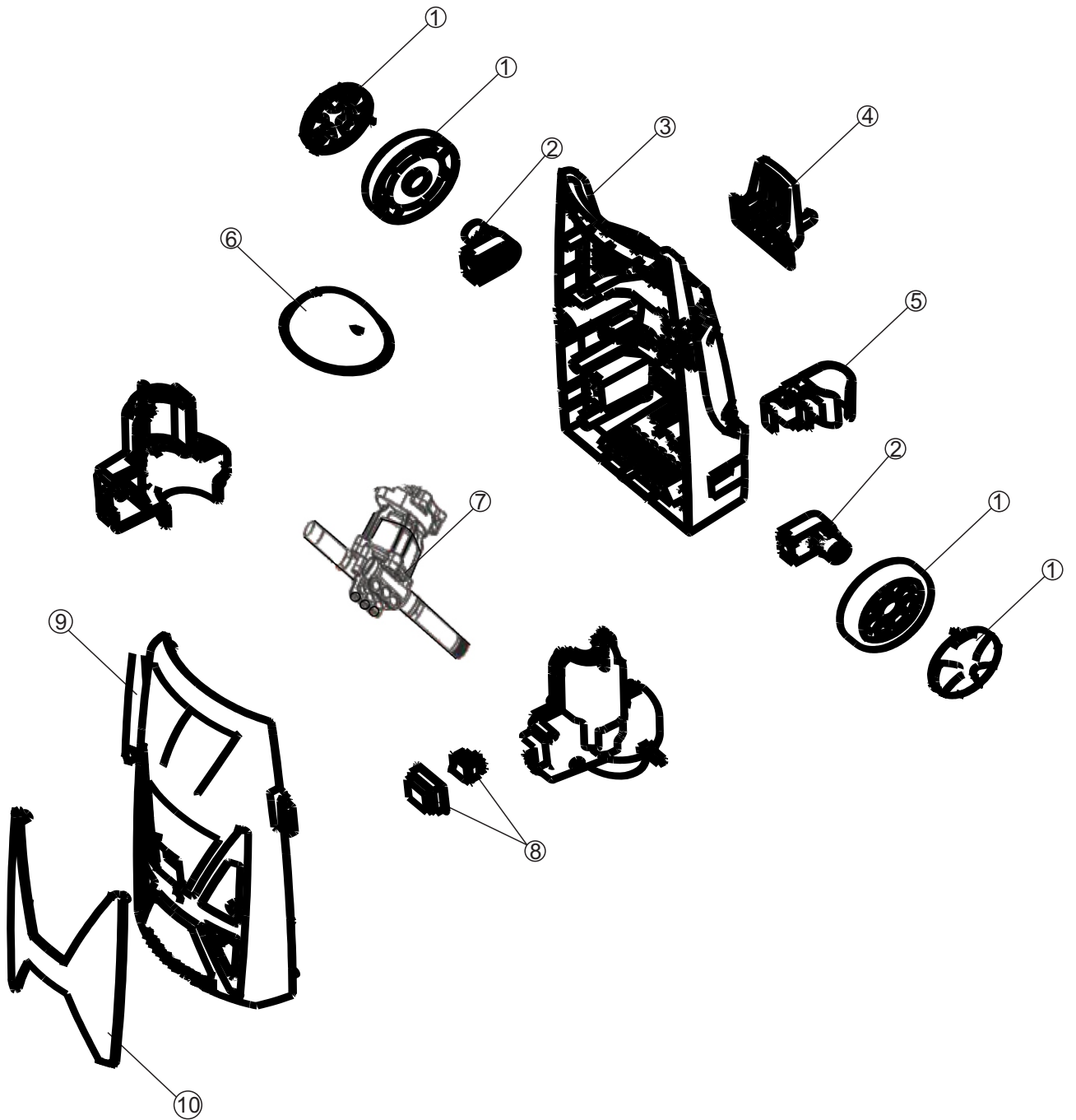



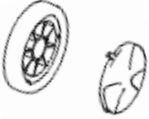

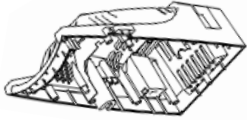
COMFORT

Vista Explodida









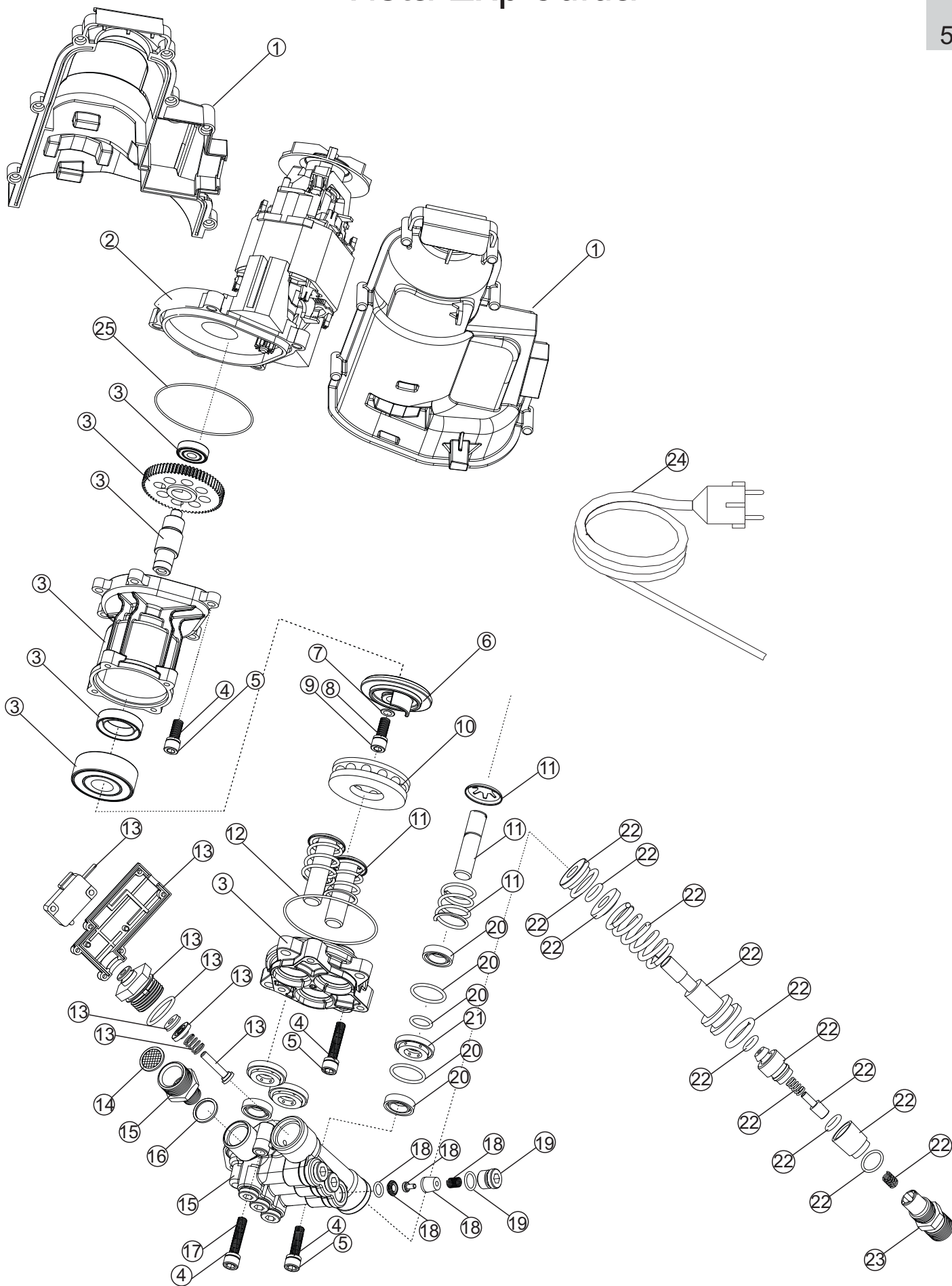

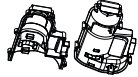
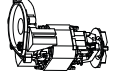
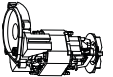
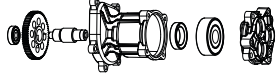

Lista De Peças 1

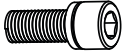
Item	Código	Descrição	Qtde.	Desenho
1	31130019	RODA	2	
2	31130018	SUPORE DA RODA	2	
3	FW000962	CARENAGEM TRAZEIRA WAP COMFORT	1	
4	FW000886	SUPORE MANGUEIRA E RECIPIENTE DE DETERGENTE	1	
5	31130001	PORTA ACESSÓRIOS	1	
6	VB70-0072	PROTEÇÃO SUPERIOR DO MOTOR	1	
7	FW000971	CONJUNTO BOMBA WAP COMFORT	1	
8	VB70-0052	INTERRUPTOR	1	
9	FW000967	CARENAGEM FRONTAL WAP COMFORT	1	
10	FW000968	ESCUDO WAP COMFORT	1	



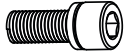

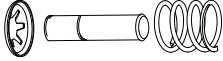



Vista Explodida

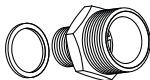

Lista De Peças 1

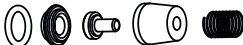
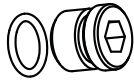
Item	Código	Descrição	Qtde.	Desenho
1	FW000964	PROTEÇÃO MOTOR WAP COMFORT	1	
2	VG70-0064	MOTOR 70BAR 127V 50/60Hz	1	
2	VG70-064A	MOTOR 70BAR 220V 50/60Hz	1	
3	FW001147	CONJUNTO ENGRENAGEM E GUIA PISTÕES	1	
4	70001006	ARRUELA DE PRESSÃO 6mm	7	
5	VG70-0018	PARAFUSO ALLEN M6x25	12	
6	APW90-74	CAME 127V 9°	1	
6	APW90-74A	CAME 220V 12°	1	
7	50186000	ARRUELA LISA 8mm	1	
8	70001008	ARRUELA DE PRESSÃO 8mm	1	
9	VB70-0029	PARAFUSO ALLEN M8x20	1	
10	VG70-0054	ROLAMENTO DE ESFERAS LINHA DOMÉSTICA	1	
11	VB70-49-51	KIT PISTÕES 12mm	1	
12	50043202	O-RING 58,42x2,62 (2141)	1	

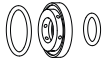
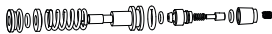
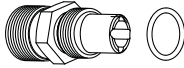
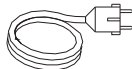
Lista De Peças 2

Item	Código	Descrição	Qtde.	Desenho
13	VG70-24-31	CONJUNTO MICRO CPL	1	
14	VB70-0018	FILTRO ENTRADA DE ÁGUA	1	
15	FW000970	KIT ENTRADA DE ÁGUA	1	
16	VG70-0017	CABEÇOTE	1	
17	30020115	PARAFUSO M6x35	1	
18	VG70-36-40	KIT VALVULA DE SUÇÃO/PRESSÃO	1	
19	VG70-41-42	KIT TAMPÃO DE VALVULAS	6	
20	VB70-44-48	KIT VEDAÇÃO	1	
21	VB70-0040	ANÉL CENTRALIZADOR	1	
22	VG70-03-16	KIT VALVULA BPS	1	
23	FW000969	CONEXÃO SAÍDA ÁGUA	1	
24	VB70-0060	CABO 2x1mm ² 5 METROS	1	
25	FW001150	O'RING 82,27x1,78 (2042)	1	

Acessórios

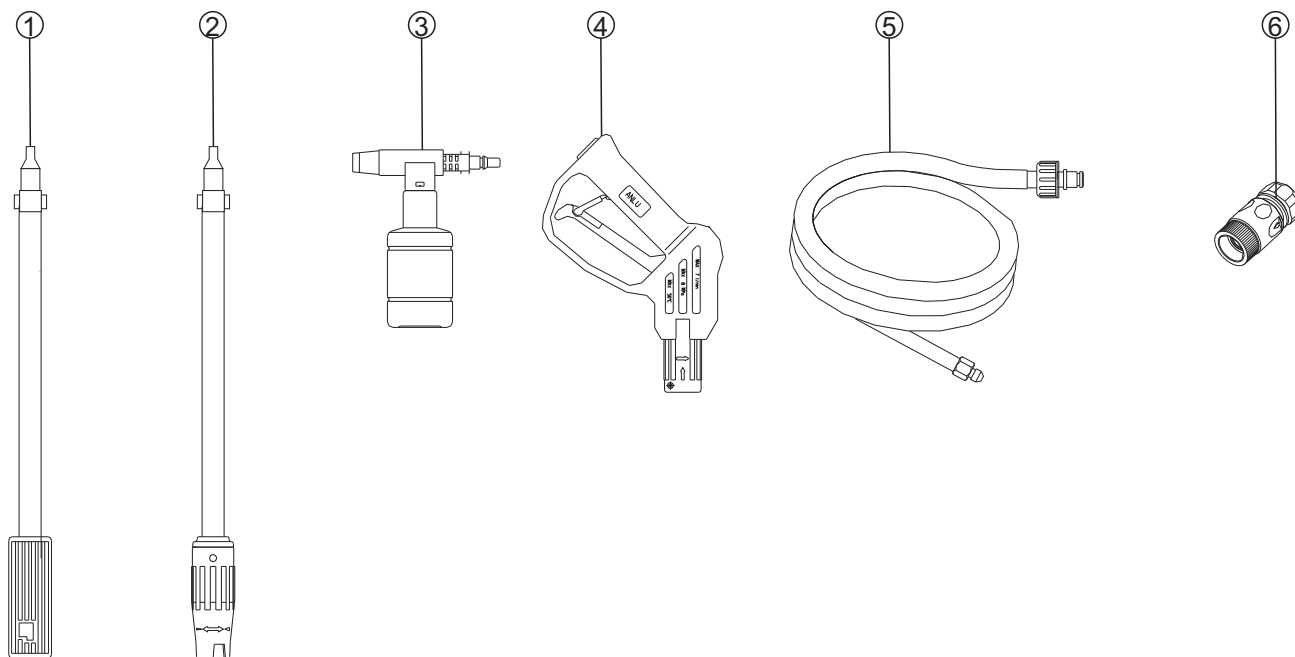

Pos: Do Item	Código	Descrição	Qtde.	Desenho
1	20011208	BAIONETA ALUMINIO ENCAIXE FINO	1	
2	VB70-0078	LANÇA VARIO 70BAR	1	
3	120EP-060	RESERVATÓRO SHAMPOO ENCAIXE FINO	1	
4	20011207	PISTOLA M22 ENCAIXE FINO	1	
4	FW002970	PISTOLA M14 ENCAIXE FINO	1	
5	VA90-0077	MANGUEIRA AP 5M CONX M22xM22	1	
5	FW002969	MANGUEIRA AP 3M CONX M22 PINO 15/ CONX M14	1	
6	VB70-0059	ENGATE RÁPIDO	1	



Fresnomaq Indústria de Máquinas S/A
Tel.: (41) 2102 0300 - Fax: 2102 0334
Rua Francisco Dal Negro, 3400, São José dos Pinhais, Pr, Brasil
www.wap.ind.br - wap@wap.ind.br